

Profile frames

- **Woodline**
- **Plastics plug-in frames**
- **Alu-Profile frames**
- **Accessories series 500**

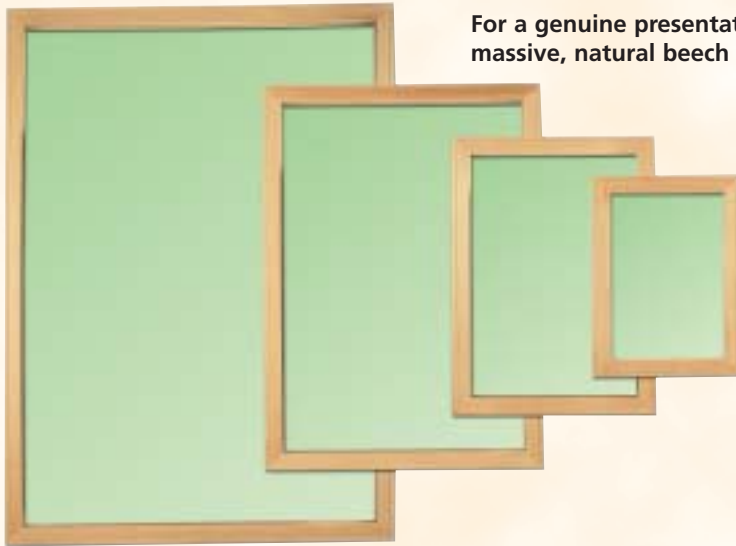

Woodline



For a genuine presentation! The showcard frame system "Woodline" made of massive, natural beech is offering various possibilities to use.

Regardless if used as single frame or complete stand - the appearance of this genuine product will always leave a special impression.

Frames in special sizes or other wood colours are possible upon request as from 50 pieces.

Note:

Being a natural product, varying shades of colour and veins are possible. Further fixing elements you will find in chapter accessories (*series 500*).

Showcard frames Woodline

Massive wooden frame made of natural beech, poster insert short side, max. poster thickness 4 mm. Also available with threaded insert M10 to take tubes without using a t-piece.

A5	
15350-00	SU 5
A5 - M10	
15351-00	SU 5
A4	
15340-00	SU 5
A4 - M10	
15341-00	SU 5
A3	
15330-00	SU 5
A3 - M10	
15332-00	SU 5
A2	
15320-00	SU 5
A2 - M10	
15321-00	SU 5
A1	
15310-00	SU 5
50 x 70 cm	
15370-00	SU 5

PS slate



Made of polystyrene, slate coated both sides, for showcard frames of same DIN size, thickness 1 mm, rounded edges, black

A5	
29650-10SU 5
A4	
29640-10SU 5
A3	
29630-10SU 5
A2	
29620-10SU 5
A1	
29610-10SU 5
50 x 70 cm	
29682-10SU 5

Chalk board marker



To directly write on PS slates, water soluble, white. Packing unit: 12 pcs (5 mm), 6 pcs. (15 mm).

5 mm	
24281-01SU 12
15 mm	
24280-01SU 6

Showcard stand Woodline



Round wooden base Ø 160 mm, fixed alu-tube black 320 mm with threaded bolt M10, woodline frame A4 or A3, natural beech with internal thread. PS slate to be ordered separately.

A4	
33384-10/320SU 1
A3	
33383-10/320SU 1



BD showcard stand Woodline

BD base Ø 255 mm black, adjustable alu-anodised tube 100-190 cm with locking screw and t-piece 550 black, showcard frame woodline A4 or A3, natural beech. PS slate to be ordered separately.

- A4**
33384-91/-1900/10.....SU 1
- A3**
33383-91/-1900/10.....SU 1



Wooden base (pair)

For upright presentation of woodline frames, made of natural beech, incl. screws for fixing.

- Large (599)**
25880-11SU 5
- Small**
25882-11SU 5



Wooden stepped base

Made of massive wood, natural beech Ø 160 mm, height 20 mm. Suits alu-anodised or powder coated alu-tubes Ø 16 mm.

- For alu-anodised tubes**
20490-00SU 5
- For powder coated alu-tubes**
20491-00/A.....SU 5



Aluminium tube

Fixed aluminium tube 320 mm, Ø 16 mm with threaded bolt M10 to fit showcard frames woodline with internal thread.

- Alu-anodised**
15714-91/320SU 5
- Black**
15714-10/320SU 5



Plastics plug-in frames



This plug-in system, registered design of OEK is stable, light-weight and available in any size as from a quantity of 10 pieces. Offering the option to create countless combinations it can be used for fairs, in shopping windows and show rooms and, of course in shops.

Supplied in kit form (consisting of profiles, connectors and suspension rings) for self mount, thus saving space and transportation costs. Assembly is simple and you need no tools.

Colours: white and red.

Note:

Fastening elements suiting the plug-in system you will find in chapter accessories (series 500).



Plastics plug-in frame

Profiles made of durable, unbreakable plastics, poster insert short side, poster thickness up to 4,5 mm. Colours: white, red.



- A4**
15140-xx.....SU 10
- A3**
15130-xx.....SU 10
- A2**
15120-xx.....SU 10
- A1**
15110-xx.....SU 10
- A0**
15100-xx.....SU 10
- 50 x 70 cm**
15170-xx.....SU 10
- 70 x 100 cm**
15172-xx.....SU 10
- Special sizes**
151xx-xx.....SU 10

H stand

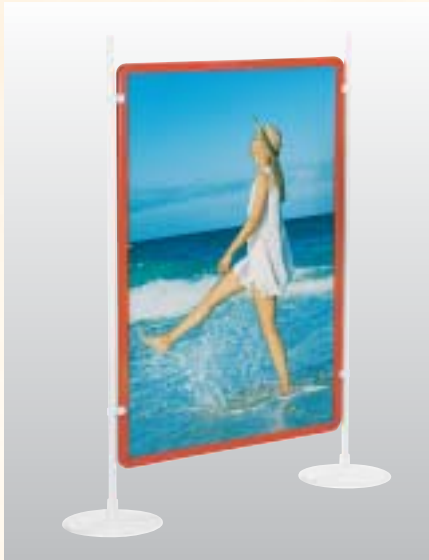

Consisting of 2 BD bases Ø 255 mm white, Alu-tube Ø 20 mm, fixed length 180 cm white with tube holders, 4 tube clips (544) white and plastics plug-in frame.

- A1**
33361-xx.....SU 1
- A0**
33360-xx.....SU 1
- 70x100 cm**
33362-xx.....SU 1

Plastics plug-in frame 4x4



By means of complimentary cross- and t-connectors you can build a multi-information frame. A large area to display information in its most attractive way, achieving additional attention by contrasting black connectors.

Subdivided into 4 frames A4, poster insert on the long outer sides, with black connectors, corners and suspension rings

- 15180-xx.....SU 10



Alu-profile frames



A system of convincing quality, designed to enable the most individual applications and handling even difficult installations. As from a quantity of 10 pieces alu-profile frames can be supplied in almost all sizes required.

By fitting leight-weight foam panels or similiar, the stable frame construction can be used to build up column panels, displays and walls and even exhibition booths.

Upon request supplied in kit form, thus saving space and transportation costs. The final assembly is more than easy: Simply put together and fastened by means of the attached Allen key.

Note:
Fastening elements suiting the alu-profile frames you will find in chapter accessories (series 500).



Alu profile frame

Stable, double-wall aluminium profile anodised, poster insert short side, poster thickness up to 4,5 mm

A4	
15240-90SU 10
A3	
15230-90SU 10
A2	
15220-90SU 10
A1	
15210-90SU 10
A0	
15200-90SU 10
50 x 70 cm	
15250-90SU 10
70 x 100 cm	
15270-90SU 10
Special sizes	
152xx-xxSU 10



NEW!



Liberty 25 with alu profile frame A2

BD base Ø 255 mm silvergrey, alu-tube fixed length 160 cm, fastening set with jubilee-clips and alu-profile frame A2

63112-91/1600.....SU 1



Showcard stand alu-profile frame

BD base Ø 255 mm silvergrey, adjustable alu-tube 65-120 cm with locking screw and t-piece black, alu-profile frame A3

33393-91/-1200/33/10.....SU 1



Accessories series 500

Using the extensive accessories range, both frames series 500 and poster rails can be fixed in countless ways of applications: easy, quick and safely.

These elements in general are suiting the following products:
 Showcard frames woodline, plastics plug-in frames, alu-profile frames, poster rails and alu clamp rails.

Fastening clip (541)

Prevents the poster from falling out or theft, clear

25940-00SU 20

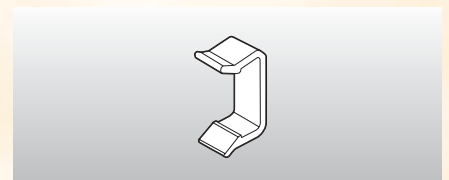

Promotion card clip (540)

To attach additional sign cards to frames series 500 in a standing or hanging position, card thickness 0,3 - 2,0 mm, clear

25920-00SU 20

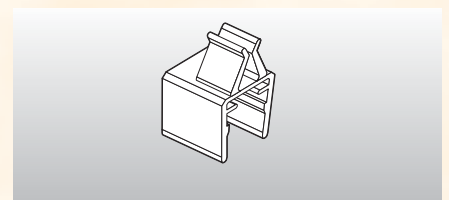

Fastener for ceiling (538)

To directly fix poster rails II, III or frames series 500 to ceilings, clear

25181-00SU 20

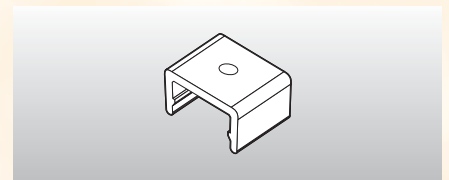

Fastener for wall (537)

To directly fix poster rails II, III or frames series 500 to walls, clear

25180-00SU 20

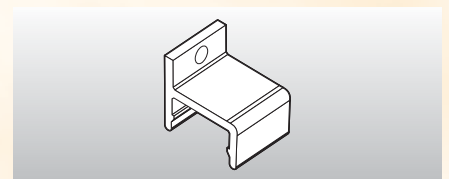

Fastener for wall (503)

Only suiting alu-profile frames for an "invisible" fixing to walls, grey. For this application please order alu-profile frames "with hole drilling". According to size we recommend using 4 fasteners.

25130-03SU 20

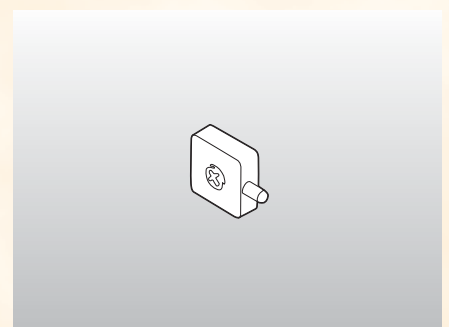
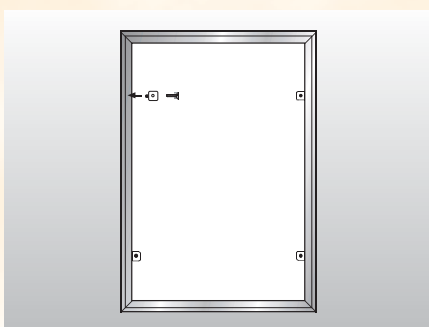

Frame support (RA 580)

To support frames series 500 in an upright position, clear. Please use 2 supports per frame.

25850-00SU 20

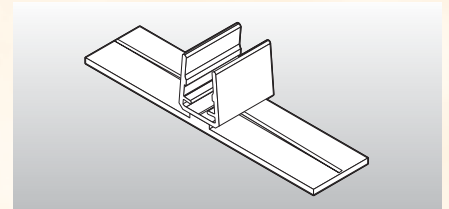

Frame support (RA 581)

To support frames series 500 in an 15° inclined position, clear. Please use 2 supports per frame.

25860-00SU 20

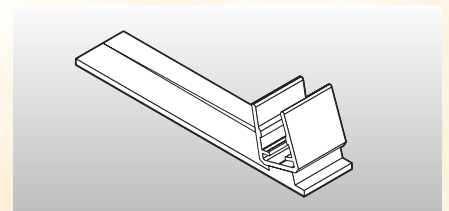

Frame support (534)

Stable support for frames series 500, anodised rectangular tube 250 mm length, frame adaptor clear, plastic end caps grey. Please use 2 supports per frame.

25870-00SU 20

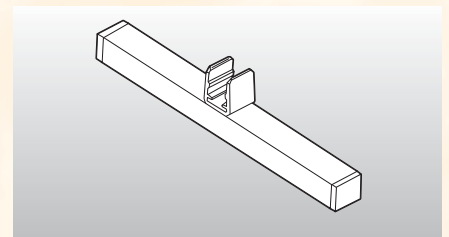

Frame adaptor (530)

To support frames series 500 with base plates (accepting tubes Ø 12 mm), clear adaptor. Base to be ordered separately.

25200-00SU 20

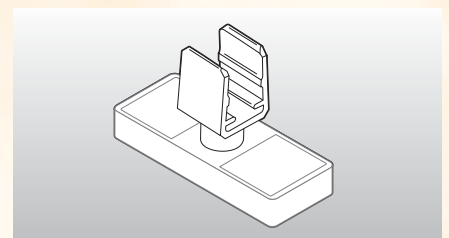

Universal clip

To fix frames series 500 to shelves with front edge, metal bows, cartons and boxes, clamp area up to 4 mm, clear.

25011-00SU 20

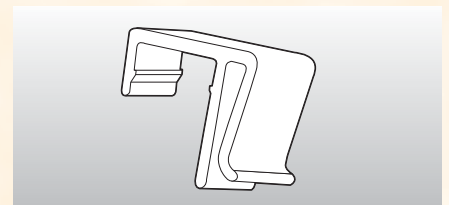

Suspension ring (502)

To suspend poster rails II and III and frames series 500, clear

25300-00SU 20

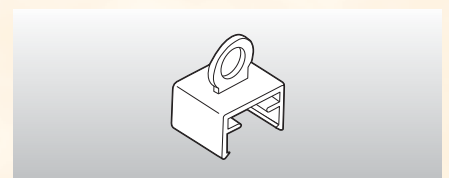

NEW!



Connecting clip (508)

To connect frames series 500, clear

25000-00SU 20

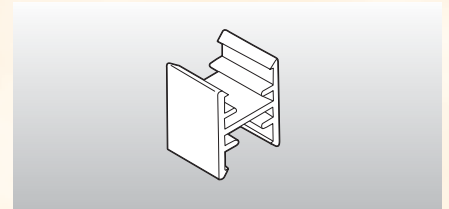

Connecting clip (520)

To connect two frames series 500 in a 90° (standard) or 180° (to be indicated) angle, grey

25020-03SU 20

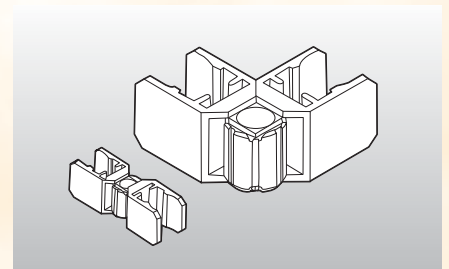

Connecting clip (521)

To connect three frames series 500 in a 90° angle each, grey

25030-03SU 20

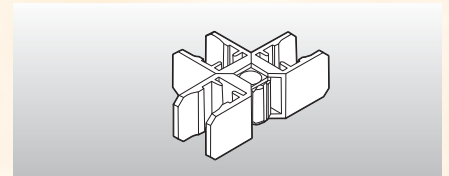

Connecting clip (522)

To connect four frames series 500 in a 90° angle each, grey

25040-03SU 20

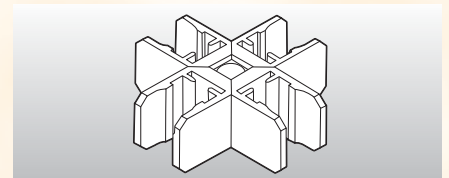

Connecting clip (523)

To connect two frames series 500 in angles of 105°, 120° or 135°, grey

25050-03SU 20

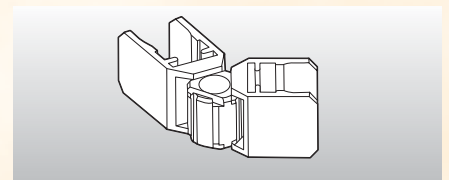

Connecting clip (524)

To connect three frames series 500 in angles of 105°, 120° or 135°, grey

25060-03SU 20

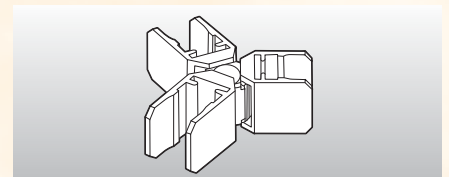

Browser clip (pair) (514)

Suits alu-profile frames used in "Posterline" stands only, clips come screwed to frames, aluminium

25890-00SU 10

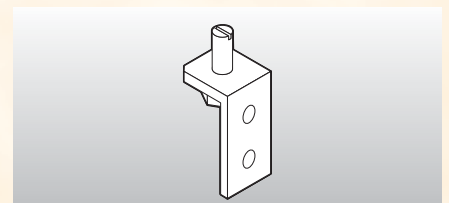

Tube clip, swivel type (pair) (572)

To suspend frames series 500 from round tube rails Ø 20 mm, clear

25521-00SU 10

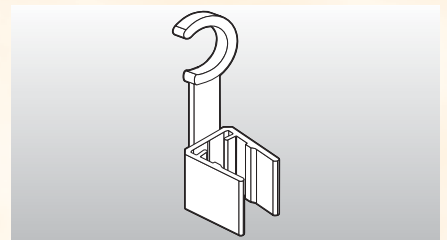

Tube clips

To fix frames series 500 to tubes. Colours: clear, grey (more resistant to breakage)

Ø 12 mm (542)
25512-xxSU 20

Ø 16 mm (543)
25516-xxSU 20

Ø 20 mm (544)
25520-xxSU 20

Ø 28 mm (545)
25528-xxSU 20

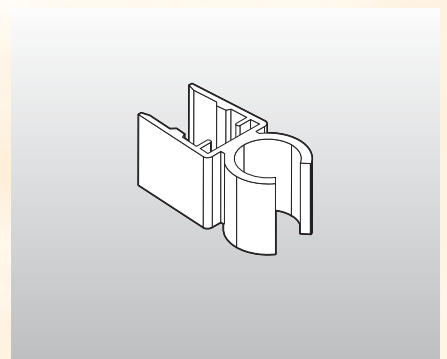

Alu clamp pole

Consisting of two alu-anodised tubes to be braced between floor and ceiling with heights ranging from 2055- 3700 mm, slipping-proof by means of spring force and suction pad, outer tube Ø 20 mm, inner tube Ø 16 mm

25550-90SU 1

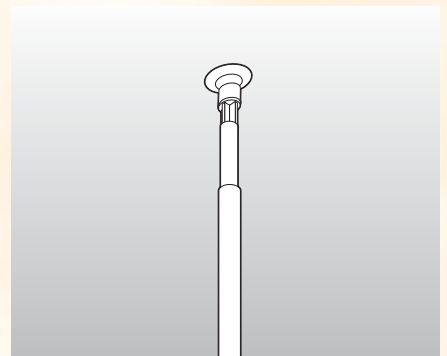

Alu cross traverse

To be fixed between clamp poles, anodised aluminium, set with two tube inserts and tube clips (mounted), cross traverse Ø 20 mm, inside width 1070 mm

25560-90/1070SU 1

