

Showcard frame system



- Showcard frames for laminated posters, standard, special sizes

- Advertising on shopping trolleys

- Price displays



- Beverages price marking

- Accessories showcard frames



Showcard frames for laminated posters

Designed for laminated posters, that will not suit standard sized frames. With these special adapted frames you do not have to worry about cutting to size! Especially recommended for use in humid areas or outdoors.

Frame design is similar to series DEKOLINE.
Poster insert short side.

Almost all accessories series 100 can be used for fixing.

Series 100
Colours: OEK standard colours and silver.

A5 plus
11508-xx.....SU 10

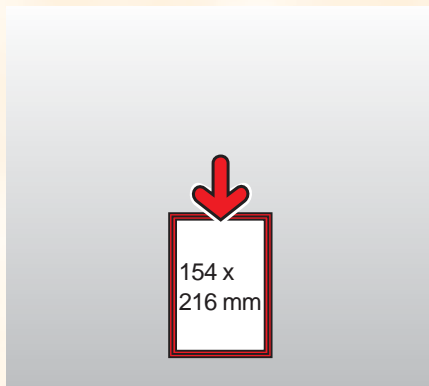

A4 plus
11408-xx.....SU 10

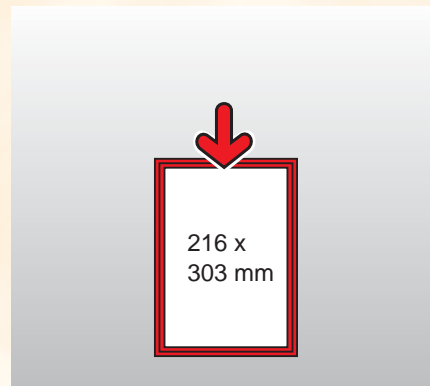

A3 plus
11308-xx.....SU 10

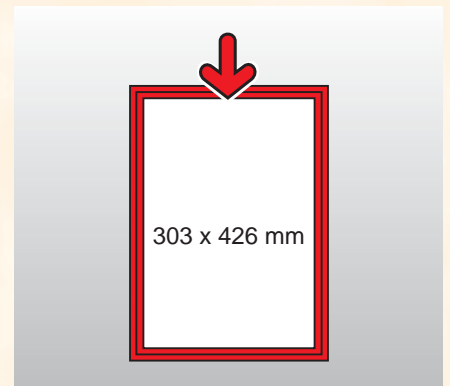

Showcard frames standard

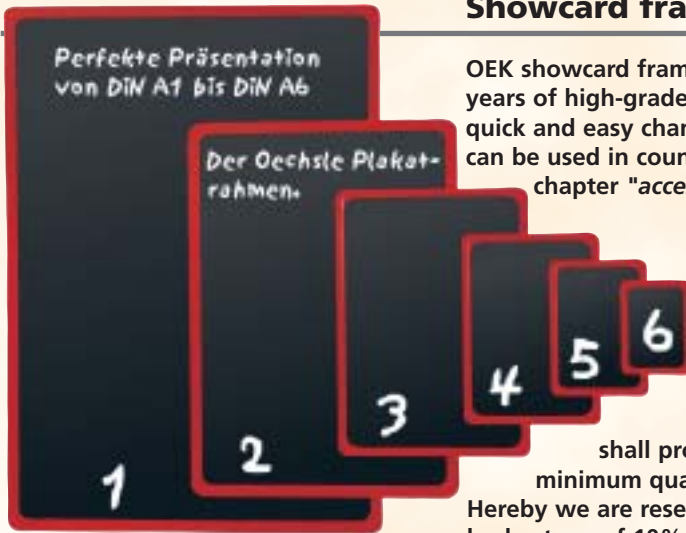

OEK showcard frames in traditional quality have been produced for almost 30 years of high-grade unbreakable plastics. These stable frames allow for a quick and easy change of posters. Using the vast accessory range, OEK frames can be used in countless applications. You will find suitable accessories in chapter "accessories showcard frames (series 100) and (series 200)".

Note: For showcard frames size A6 to A3 use accessories series 100.

For showcard frames size A2 to A1 use accessories series 200.

Colours:

You are looking for different colours than offered? We shall produce them for you in your desired colour starting at a minimum quantity of 500 pieces at extra costs.

Hereby we are reserving the right of supplying you with a surplus respectively shortage of 10% of the ordered quantity.

Short side entry, colours: OEK standard colours, cream, ultramarine blue, light red, brown, clear, silver, chromium.
 Long side entry, colours: OEK standard colours, clear.

↓ A6 11600-xx.....SU 10	↓ A5 11500-xx.....SU 10	↓ A4 11400-xx.....SU 10
← A6 long side entry 11601-xx.....SU 10	← A5 long side entry 11501-xx.....SU 10	← A4 long side entry 11401-xx.....SU 10

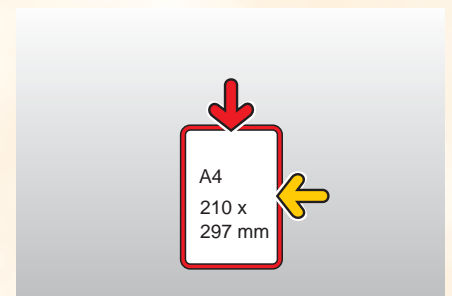
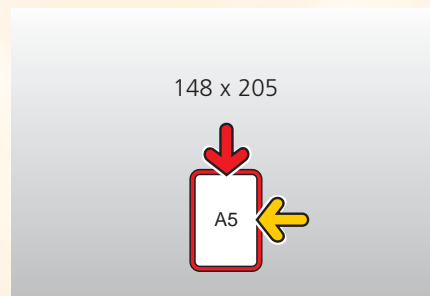
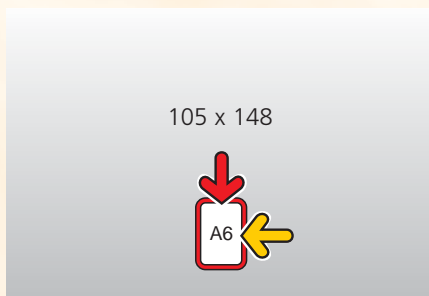

↓ A3 11300-xx.....SU 10
← A3 long side entry 11301-xx.....SU 10

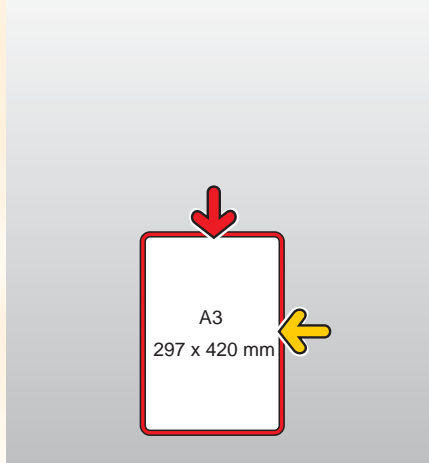

A2 12200-xx.....SU 10



A1 12100-xx.....SU 10

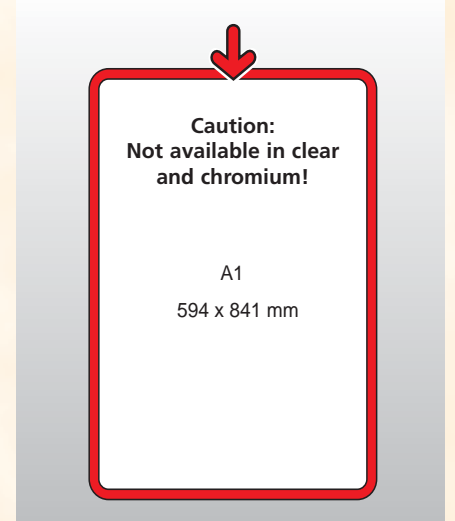

PVC poster protectors

Suits showcard frames of same DIN size, folded short side, thickness 0,3 mm (A1 0,4 mm), non reflective, clear.



A6	
29260-00SU 10
A5	
29250-00SU 10
A4	
29240-00SU 10
A3	
29235-00SU 10
A2	
29220-00SU 10
A1	
29210-00SU 10

Special sizes showcard frames

With more than 20 different special sizes we are your perfect partner for customised solutions. Suitable accessories you will find in chapter *accessories showcard frames (series 100) and (series 200)*.

Colours: white and red.

You are looking for different colours than offered? We shall produce them for you in one of our standard colours starting at a minimum quantity of 500 pieces at extra costs.

Hereby we are reserving the right of supplying you with a surplus respective shortage of 10% of the ordered quantity.

170 x 240 (series 100)

11853-xx.....SU 10



172 x 260 long side entry (series 100)

11859-xx.....SU 10

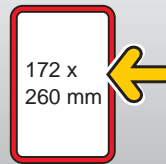

243 x 340 (series 100)

11850-xx.....SU 10

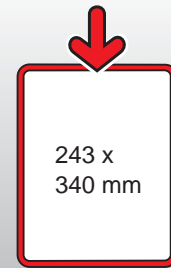

243 x 335 (series 100)

11851-xx.....SU 10

243 x 335 long side entry (series 100)

11852-xx.....SU 10

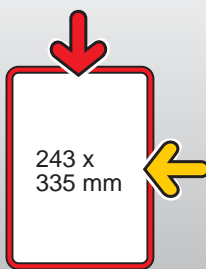

340 x 494 long side entry (series 100)

11860-xx.....SU 10

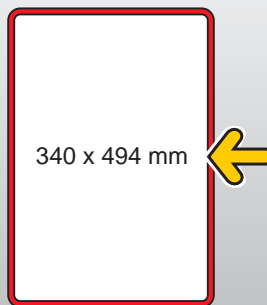

500 x 700 (series 200)

12550-xx.....SU 10

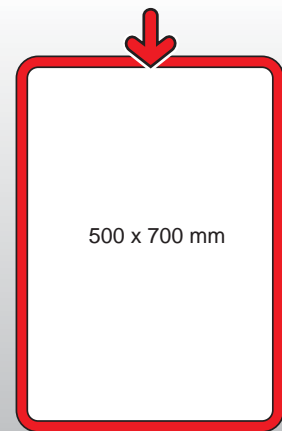

5,5" x 3,5" long side entry (series 100)

11837-xx.....SU 10



7" x 5,5" long side entry (series 100)

11835-xx.....SU 10



7" x 11" (series 100)

11833-xx.....SU 10

7" x 11" long side entry (series 100)

11834-xx.....SU 10

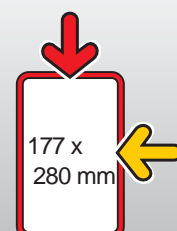



SHOWCARD FRAMES SPECIAL SIZES

Showcard frame system
SPECIAL SIZES

11" x 14" (series 100)

11830-xx.....SU 10



292 x 292 (series 200)

12530-xx.....SU 10

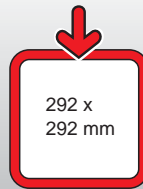

297 x 297 (series 100)

11840-xx.....SU 10



400 x 400 (series 100)

11841-xx.....SU 10

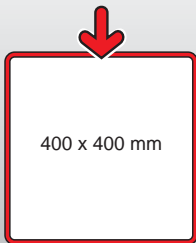

420 x 420 (series 100)

11842-xx.....SU 10



595 x 595 (series 200)

12540-xx.....SU 10

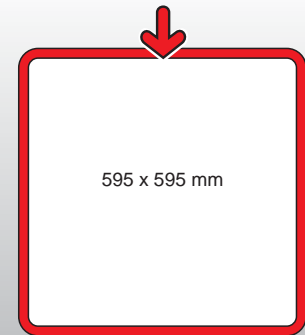

105 x 297 long side entry (series 100)

11857-xx.....SU 10



140 x 297 (series 100)

11856-xx.....SU 10

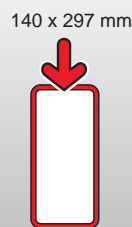

140 x 417 (series 100)

11855-xx.....SU 10

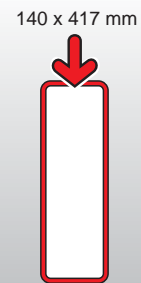

205 x 415 (series 100)

11854-xx.....SU 10

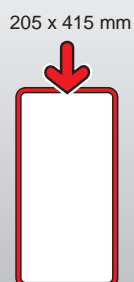

210 x 600 long side entry (series 200)

12552-xx.....SU 10

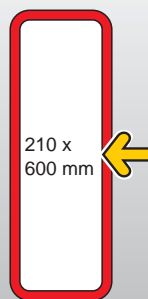

290 x 595 (series 200)

12551-xx.....SU 10

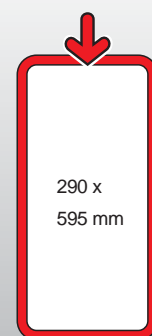

Bicycle swivel frame A6

A6 with cross bar, swivel frame with ball joint and tube clip for Ø 22 mm. Colour: white, yellow
18660-xx.....SU 10

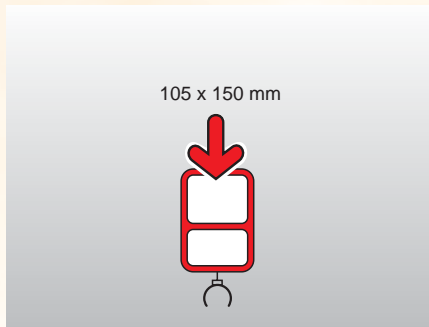

U-frame 148 x 210 (series 100)

For posters size A5 landscape or A4 portrait
11407-xx.....SU 10



A3 with cross bar

To insert two posters, long side entry.
11304-xx.....SU 10

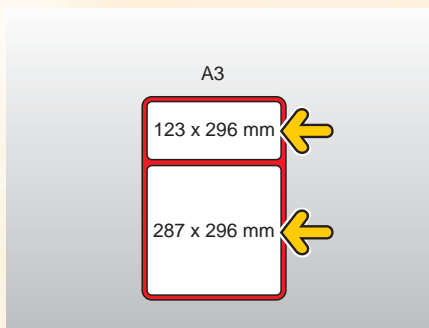

A4 with cross bar

11404-xx.....SU 10

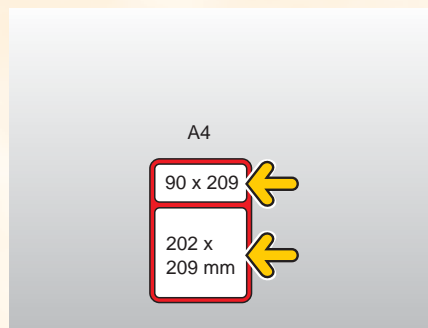

Getting to grips with your customer for a long while?

Guide your customer through the colourful world of offers - single minded and efficiently:

The grip display for shopping trolleys is the ideal answer for your adverts, special offers, general information such as "Where to find?" or branding. Your message won't be missed - that's for sure!

Grip display A5 landscape



2-part anodised aluminium profile with 2 plastic end caps in red, grey or orange. Other colours upon request. Available for shopping trolleys with either round or panoramic grip. Overall size: 220 x 163 mm.

Round grip

18020-xx.....SU 10

Panoramic grip

18021-xx.....SU 10

Advertising in motion - always up-to-date!

The basket display is suitable for almost all shopping trolleys and is placing your advert at customer's first sight. Use the possibility to present your message double-sided. Only information sells!



Basket display for shopping trolleys A4 landscape (pair)

To be attached by screws or clips, with drain slots for rain water, supplied with 4 connecting clips, made of plastic, colours: traffic red and black. Other colours upon request.

18040-xx.....SU 10

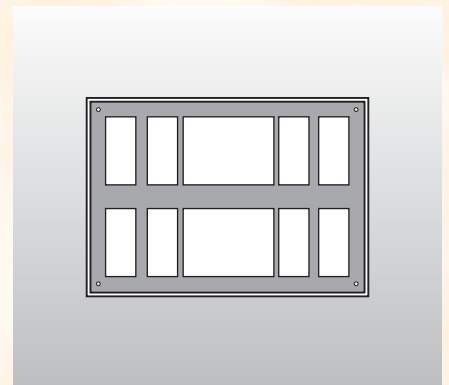

PVC cutting

Suits grip display and basket display (2 cuttings necessary per pair) to protect your advert or sale information, non-reflective PVC, thickness 0,3 mm, clear.

A5

29050-00.....SU 10

A4

29040-00.....SU 10

Price displays (series 100):

OEK price displays are offering a quick and neat price marking system by means of folded and spiral bound numbers. Combined with the OEK accessory range displays can be precisely positioned wherever needed.

Frame with price display



Showcard frame A3 or A4 with additional price display, both sides with 5 spiral-bound numbers each, printed black with big and small numbers. Insert for posters or wording A4 or A5 landscape. Available colours upon request.

- A4**
14140-xx.....SU 10
- A3**
14130-xx.....SU 10



Price display PD A5

Price display made of high-quality plastics, for 6 folded numbers, OEK standard colours, size for wording 210 x 74 mm, supplied without numbers, cutting for wording and PVC cutting.

- 14160-xx.....SU 10

PVC cutting for PD A5

PVC cutting 210 x 74 mm to protect numbers, clear
29076-02.....SU 10

Plain cutting for wording for PD A5

PVC cutting 210 x 74 mm, white
24150-01.....SU 10

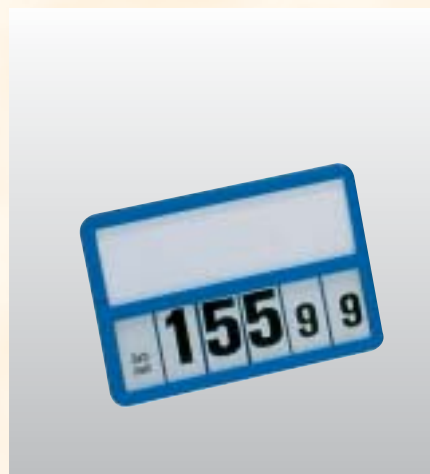

Price display PD 210 x 190

Designed for use in fruit and vegetable shelves, for 6 folded numbers, front with 2 inserts for wording (top 40 x 190 mm, bottom 55 x 190 mm), back with additional adaptor for Klick accessories, colours: green. Supplied without numbers and cutting for wording.

- 14280-07.....SU 10



Folded numbers for PD A5 & PD 210 x 190

Made of white PVC, printed black with big and small numbers, sheet size 418 x 180 mm with 6 strips 418 x 30 mm each.

- 24056-00.....SU 10



Beverages price marking

Marking brand names with quick and easy pricing - these are the main advantages of our range for the beverages pricing.

Display for beverages

Price display 250 x 530 x 1 mm white, arrow shaped with green border, insert for posters A5 landscape (210 x 148 mm), incl. 2 cassettes with 5 spiral bound numbers each, printed red for pricing of beverages with basic price.

14547-00SU 10



Price cassette for beverages

Price cassette, size 350 x 220 mm. Plastic housing white or red with 3 cassettes to be opened individually, clear. Top cassette for poster or wording A5 landscape. Second and third cassette with folded numbers red/black and basic price information. Packing unit: 10 pcs.

14362-xxSU 10



Special accessories for Price cassette for beverages

Suspension (380)

With hook for tubes Ø 12 mm, clear.
Packing unit: 20 pcs.

24800-00SU 20

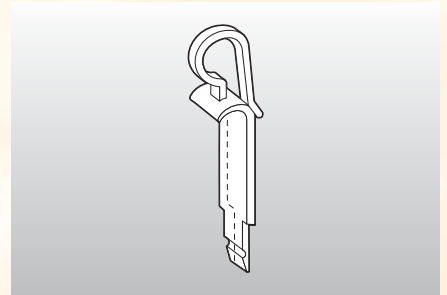

Suspension (381)

With hook for tubes Ø 26 mm, clear.
Packing unit: 20 pcs.

24810-00SU 20

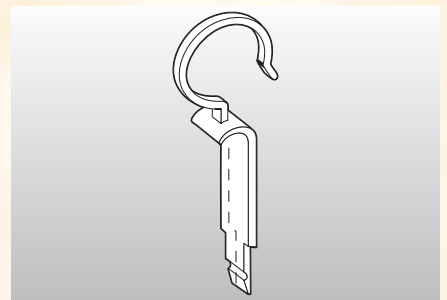

Suspension (382)

Suspension with ring, clear.
Packing unit: 20 pcs.

24820-00SU 20

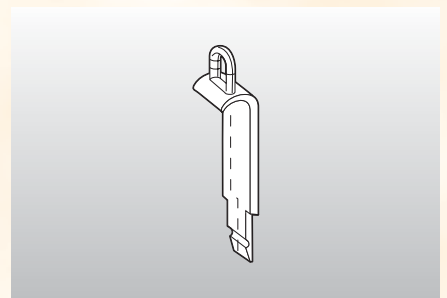

Suspension (383)

To suspend 2 cassettes for beverages
(back to back), clear.
Packing unit: 20 pcs.

24830-00SU 20

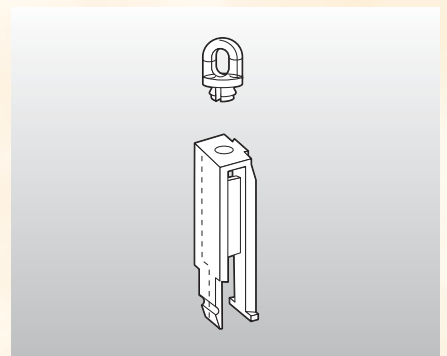

Showcard frame system
BEVERAGES PRICE MARKING

Accessories showcard frames

Using the vast accessory range, showcard frames can be fixed for manifold applications: quick, easily and securely. These elements are suitable for frames as follows: Showcard frames standard, laminate, special size, Dekoline, Twin-Set (only lateral fixing) and price displays. Should you fail to find a suitable fixing for your special requirement, we would be gladly to assist you.

Note:

For showcard frames size A6 to A3 use *accessories series 100*.

For showcard frames size A2 to A1 use *accessories series 200*.

Suspension ring 90°

With ring to suspend frames 90°, for lateral poster insert, clear.

series 100 (101)	
21300-00	SU 20
series 200 (201)	
22300-00	SU 20

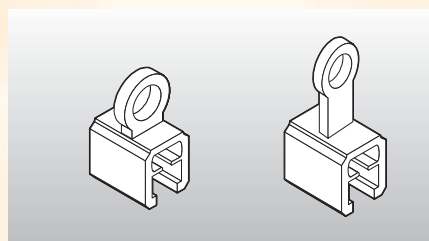

Suspension ring parallel

With ring to suspend frames parallel, for lateral poster insert, clear.

series 100 (101a)	
21310-00	SU 20
series 200 (201a)	
22310-00	SU 20

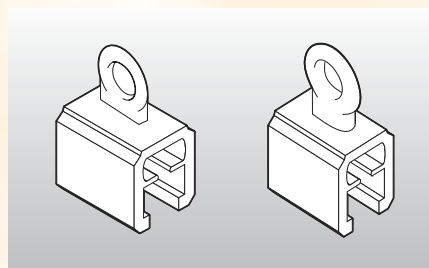

Suspension ring, swivel type

With ring to suspend frames, any position, for lateral poster insert, clear.

series 100 (101b)	
21315-00	SU 20
series 200 (201b)	
22315-00	SU 20

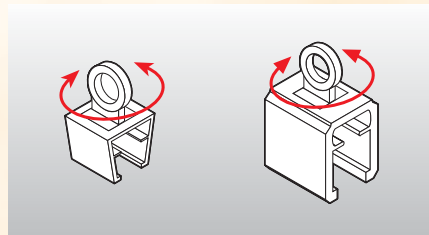

Suspension hook, short

With hook to suspend frames with lateral poster insert, clear.

series 100 (102)	
21320-00	SU 20
series 200 (202)	
22320-00	SU 20

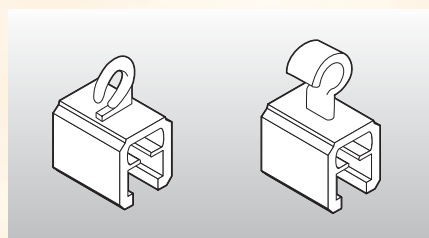

Suspension hook (pair)

With hook to suspend frames with top poster insert, clear.

series 100 (111)	
21370-00	SU 10
series 200 (211)	
22370-00	SU 10

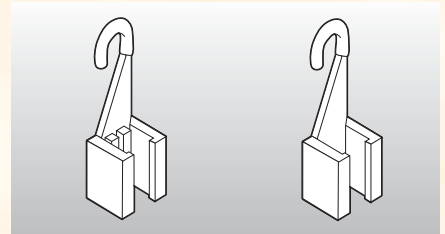

Suspension hook short (pair)

Same as (111) but short version, clear.

series 100 (111a)	
21360-00	SU 10

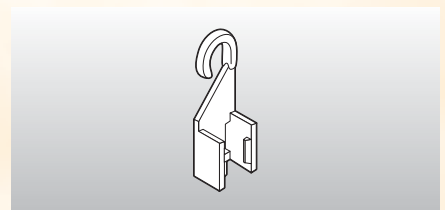

Hanging hook

To attach frames to wires etc., for frames with lateral poster insert, clear.

series 100 (103)	
21400-00	SU 20
series 200 (203)	
22400-00	SU 20

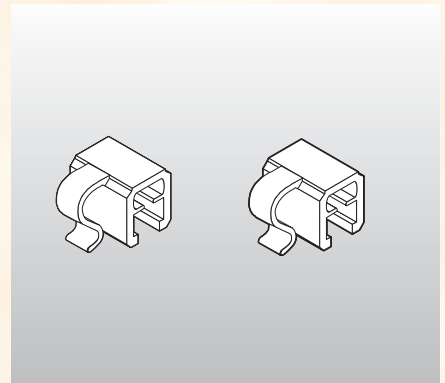

Suspension hook, 2-part (pair)

To attach frames to wires etc., for frames with top poster insert, grey.

series 100 (136)	
21410-03	SU 10

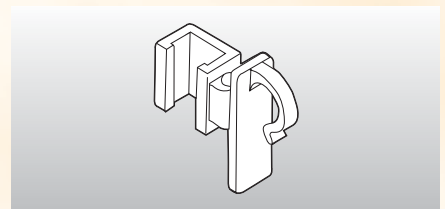

Fastening clip for wires (pair)

To attach frames to wires or shopping trolleys, clear.

series 100 (139)	
21430-00	SU 10

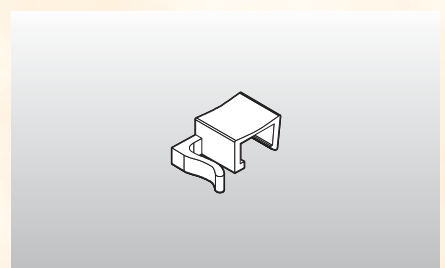

Hanging hook, swivel type (pair)

To attach frames with top poster insert to wires etc., with up to Ø 8 mm, clear.

- series 100 (104)**
21330-00SU 10
- series 200 (204)**
22350-00SU 10

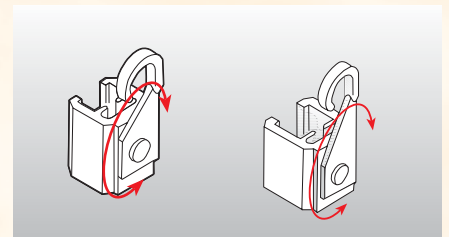

Hanging hook big, swivel type (pair)

To attach frames with top poster insert to wires etc., with up to Ø 10 mm, clear.

- series 100 (104a)**
21331-00SU 10
- series 200 (204a)**
22330-00SU 10

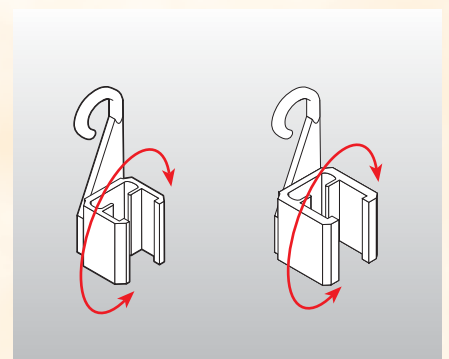

Tube clip, swivel type (pair)

To suspend frames from round rails, clip Ø 22 mm, clear.

- series 100 (172)**
21610-00SU 10
- series 200 (272)**
22610-00SU 10

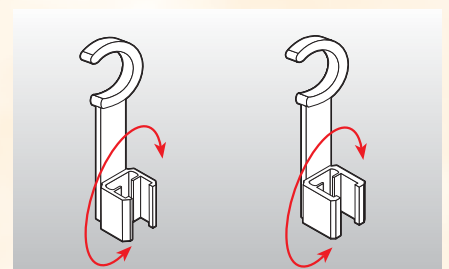

Frame connector

To connect frames of the same series, clear.

- series 100 (108)**
21000-00SU 20
- series 200 (208)**
22000-00SU 20

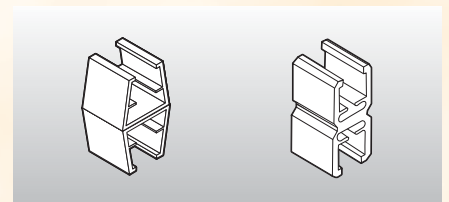

Frame connector swivel type

To connect frames of the same series, clear.

- series 100 (108b)**
21010-00SU 20
- series 200 (208b)**
22010-00SU 20

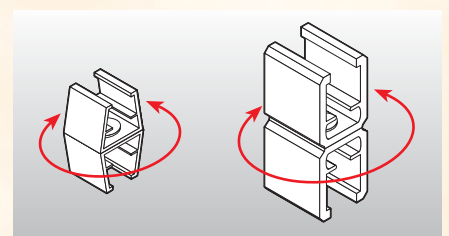

Frame connector (108h)

To connect frames series 100 with top poster insert, clear.

21020-00SU 20

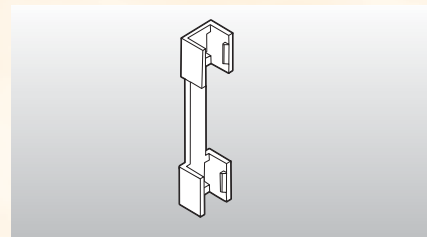

Frame connector (109)

To connect frames series 100 with frames series 200, clear.

21030-00SU 20

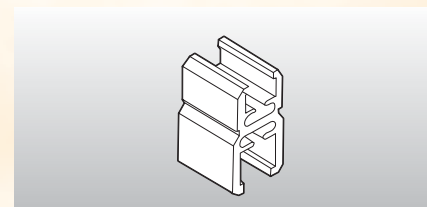

Promotion card clip

To attach posters or signs to frames, standing or hanging position,
series 100: poster thickness 0,3 - 1,0 mm,
series 200: poster thickness 0,3 - 2,0 mm,
clear.

series 100 (140)

21920-00SU 20

series 200 (240)

22920-00SU 20

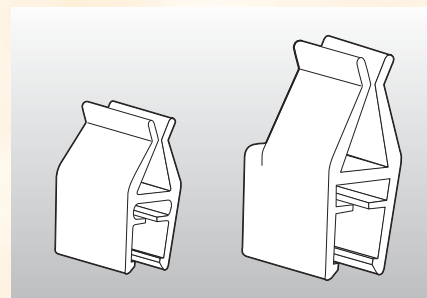

Magnetic ring (116)

1 magnet, for attachment to ceilings, profiles etc., to hang frames with suspension hooks, up to approx. 2,8 kgs, clear or grey.

20601-xxSU 20

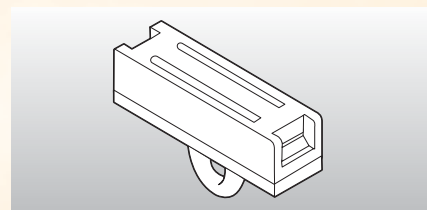

Magnetic ring (116a)

2 magnets, for attachment to ceilings, profiles etc., to hang frames with suspension hooks, up to approx. 5,6 kgs, white.

20602-01SU 20

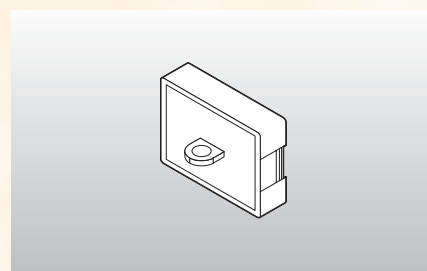



Magnetic fastener round

For direct attachment of frames to metallic surfaces, Ø 30 mm, OEK standard colours.

- series 100 (112)**
21200-xx.....SU 20
series 200 (212)
22200-xx.....SU 20

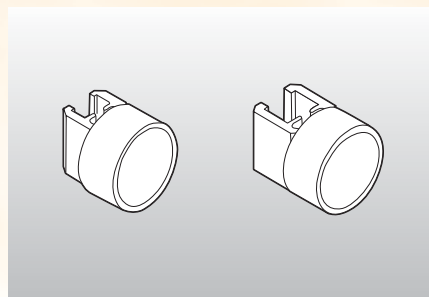

Magnetic fastener rectangular, swivel type

With 360° rotary magnet, up to approx. 2,8 kgs, clear, grey (series 100 only).

- series 100 (113)**
21220-xx.....SU 20
series 200 (213)
22220-00.....SU 20

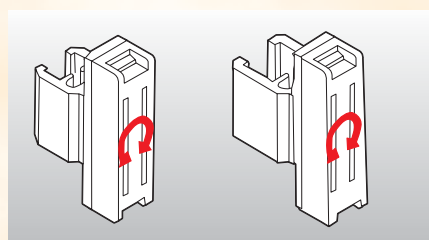

Magnetic fastener rectangular (117)

90° to frames, up to approx. 2,8 kgs, clear and grey.

- 21260-xx.....SU 20

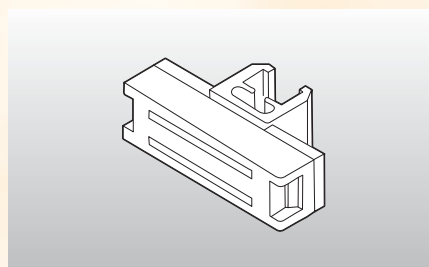

Magnetic fastener square, parallel

Parallel to frame, up to approx. 5,6 kgs, white with clear adaptor.

- series 100 (118a)**
21230-01.....SU 20
series 200 (218a)
22230-01.....SU 20

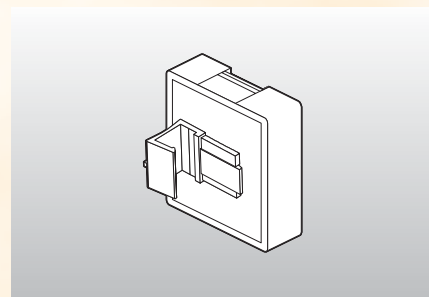

Magnetic fastener square, 90°

90° to frames, up to approx. 5,6 kgs, white with clear adaptor.

- series 100 (118b)**
21250-01.....SU 20
series 200 (218b)
22250-01.....SU 20

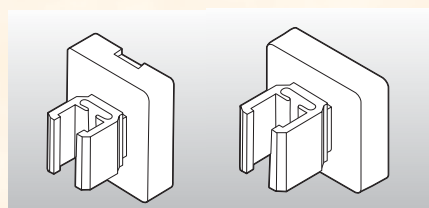

Magnetic fastener square, without adaptor (118)

Magnetic fastener to fix either parallel or 90° adaptors, up to approx. 5,6 kgs, white.

21240-01SU 20

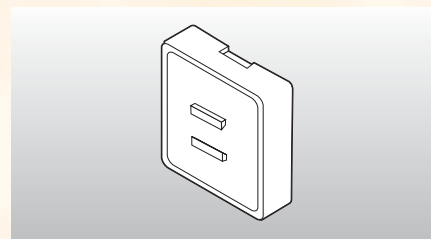

Adaptor parallel

For fixing to magnetic fastener (118), clear.

series 100
21231-00SU 20

series 200
22231-00SU 20

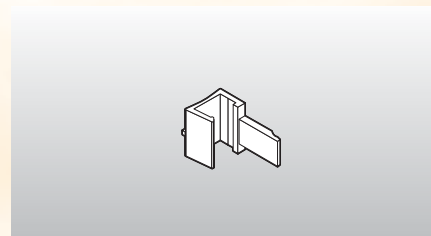

Adaptor 90°

For fixing to magnetic fastener (118), clear.

series 100
21251-00SU 20

series 200
22251-00SU 20

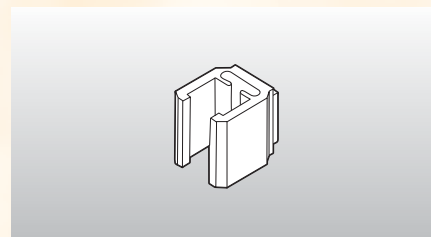

NEW!



Magnetic tube clip

For tubes Ø 12 mm, with 2 magnets, up to approx. 5,6 kgs, white. We recommend to use 2 clips.

21255-01SU 20

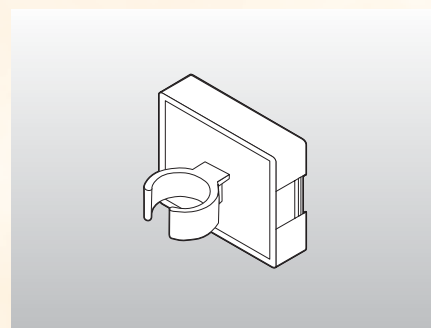

MF magnetic base

Plastic base with 4 magnets, up to approx. 11 kgs, for tubes Ø 12 mm, grey

20370-03SU 10

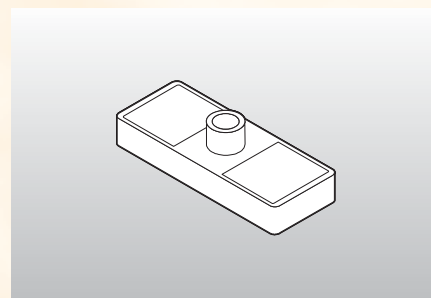

NEW!

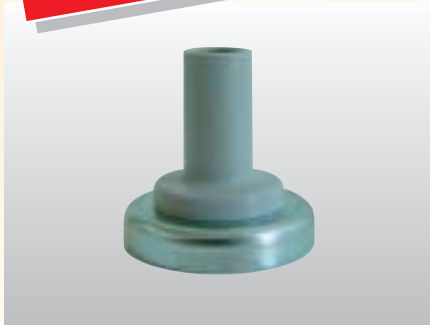

Magnetic base Ø 50 mm with tube holder

Round magnet chromium, up to approx. 9 kgs, with tube holder grey for tubes Ø 12 mm

20375-03SU 10

Retaining clip

To prevent falling out or taking away of posters, clear.

series 100 (141)
21940-00SU 10

series 200 (241)
22940-00SU 10

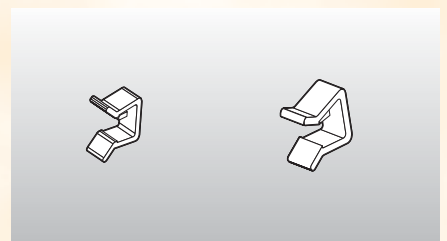

Browser clip (107)

For swivel mounting of showcard frames series 100, used with Infoline models, clear.

21880-00SU 20

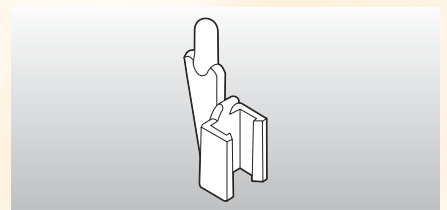

Browser clip with metal-pivot (207a)

Very stable, screwed version with metal-pivot for frames series 200, used with Infoline models, clear.

22890-00SU 20

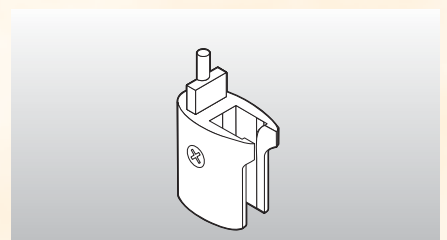

Adhesive suction pad

To attach frames to glass or smooth surfaces, 2-parts, to be mounted for either parallel or 90° fixing, clear.

21706-00SU 20

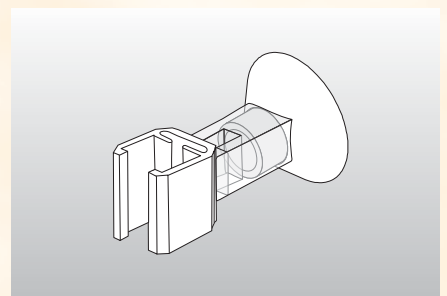

Adhesive suction pad parallel

To attach frames to glass or smooth surfaces, clear.

series 200 (244)
22705-00SU 20

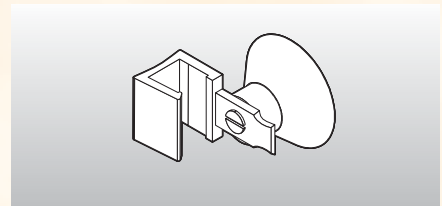

Adhesive suction pad 90°

To attach frames to glass or smooth surfaces, clear.

series 200 (243)
22700-00SU 20

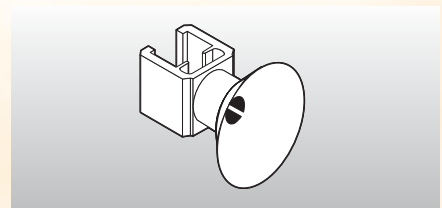

Panel hanger (176)

To fix frames series 100 to vertical panels, thickness 16 mm, in an either standing or hanging position, clear.

21190-00SU 20

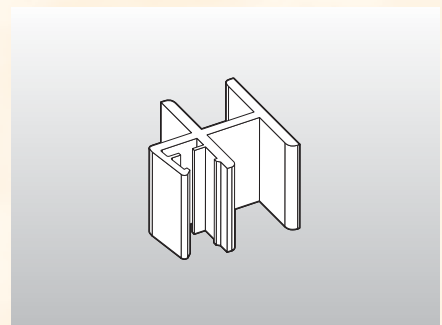

Frame base support RA1

To support frames in an upright position, series 100 1-part, series 200 2-part, clear.

series 100
21750-00SU 20
series 200
22750-00SU 20

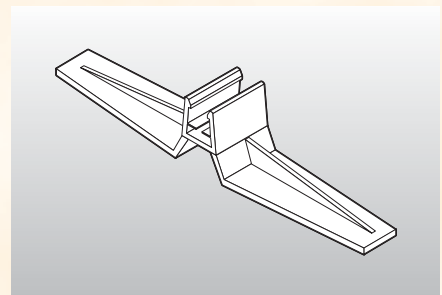

Frame base support RA2

To support frames in a 15° inclined position, series 100 1-part, series 200 2-part, clear.

series 100
21760-00SU 20
series 200
22760-00SU 20

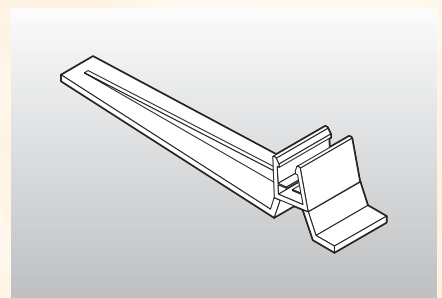

Tube clips series 100

Tube clips to attach frames series 100 to tubes with different diameters, clear.

Ø 8 mm (119)	
21508-00SU 20
Ø 10 mm (120)	
21510-00SU 20
Ø 12 mm (121)	
21512-00SU 20
Ø 14 mm (122)	
21514-00SU 20
Ø 18 mm (123)	
21518-00SU 20
Ø 22 mm (124)	
21522-00SU 20
Ø 28-35 mm (125)	
21528-00SU 20

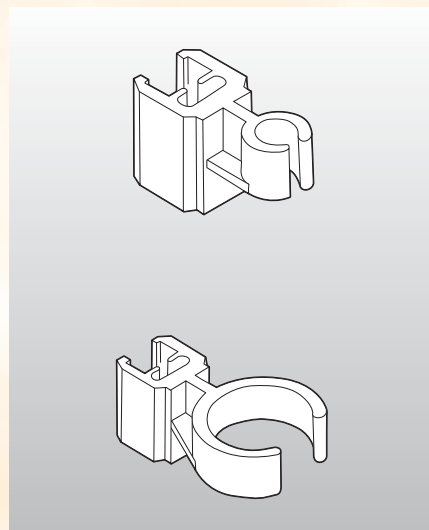

Tube clips series 200

Tube clips to attach frames series 200 to tubes with different diameters, clear.

Ø 10 mm (220)	
22510-00SU 20
Ø 12 mm (221)	
22512-00SU 20
Ø 14 mm (222)	
22514-00SU 20
Ø 16 mm (223)	
22516-00SU 20
Ø 20 mm (229)	
22520-00SU 20
Ø 22 mm (224)	
22522-00SU 20
Ø 28-35 mm (225)	
22528-00SU 20

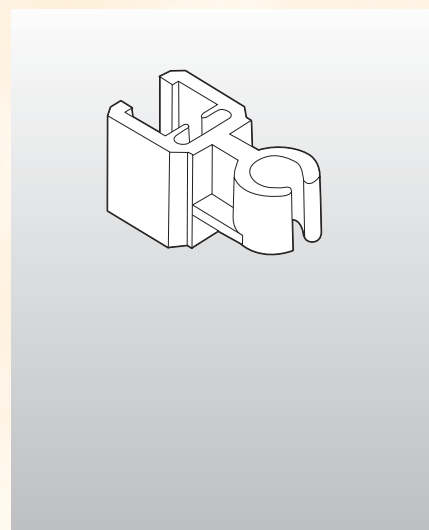

Ceiling suspension (129)

With magnet Ø 50 mm and adjustable chromium tube, 60 - 120 cm with grey lever clamp. Magnet force up to approx. 9 kgs. Frames and t-piece to be ordered separately.

20627-00SU 10
----------	------------

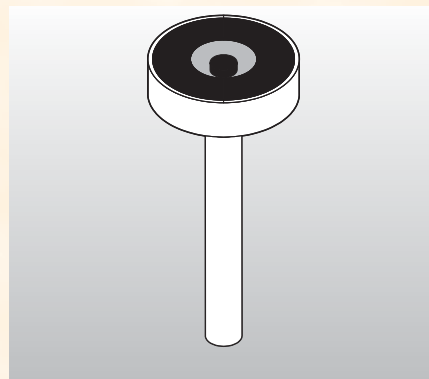

Shelf mount

With internal thread M5 and screw, grey.

series 100 (106)

21100-03SU 20

series 200 (206)

22100-03SU 20

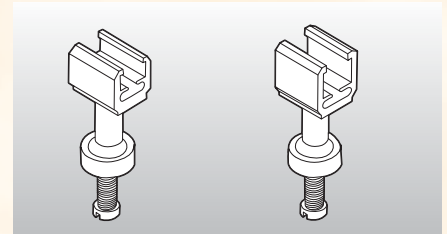

Flexible clip with G-clamp

To fix frames to shelves etc., from 1 - 40 mm thickness, not mounted, white.

series 100 (114)

21110-26SU 10

series 200 (214)

22110-26SU 10

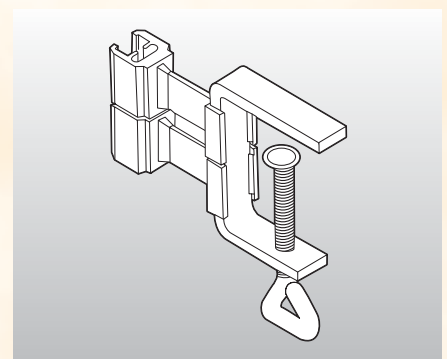

Flexible clip to stick on

To fix frames to smooth surfaces, such as shopping windows etc., 2-part, not mounted, white. We recommend to use two clips per frame.

series 100 (115)

21119-00SU 20

series 200 (215)

22119-00SU 20

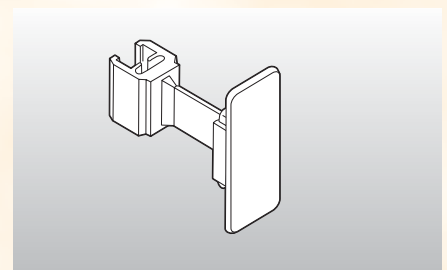

Flexible clip with Klick adaptor (155)

For magnetic fastener (313 or 329), to attach frames series 100 to shelves etc., white.

21170-26SU 10

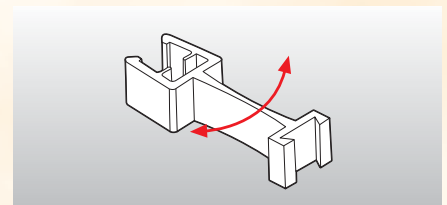

Wall fastener

For screw-mounting, type "a" with double adhesive to stick on, for frames series 100 (1-part), for frames series 200 (2-part), clear.

series 100 (135)	
21130-00	SU 20
series 200 (235)	
22130-00	SU 20
series 100 (135a)	
21131-00	SU 20
series 200 (235a)	
22133-00	SU 20

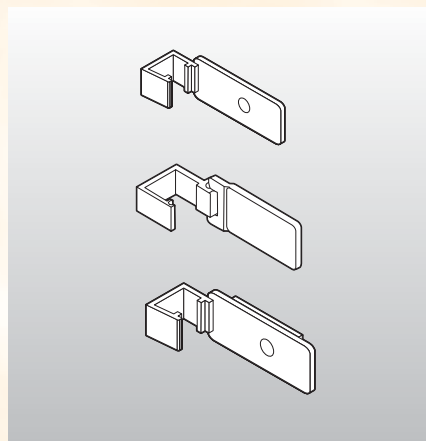

Wall fastener big

For screw-mounting, type "as" with double adhesive to stick on, for frames series 200, especially recommended for size A1 and 50x70 cm, clear.

series 200 (235s)	
22132-00	SU 20
series 200 (235as)	
22135-00	SU 20

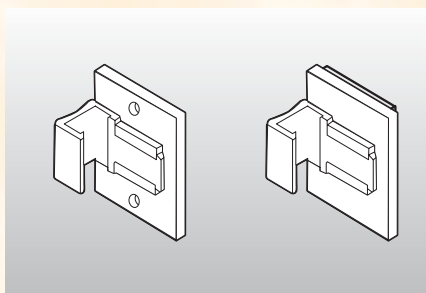

Keyhole fastener (145)

For parallel fixing of frames series 100 to hooks or screws, clear

21180-00	SU 20
----------------	-------

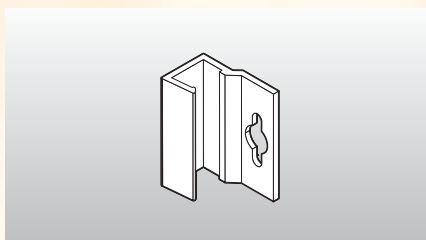

Fastener with rotary clip

For screw-mounting, type "a" with double adhesive, 360° rotary clip, clear.

series 100 (110)	
21120-00	SU 20
series 200 (210)	
22120-00	SU 20
series 100 (110a)	
21125-00	SU 20
series 200 (210a)	
22125-00	SU 20

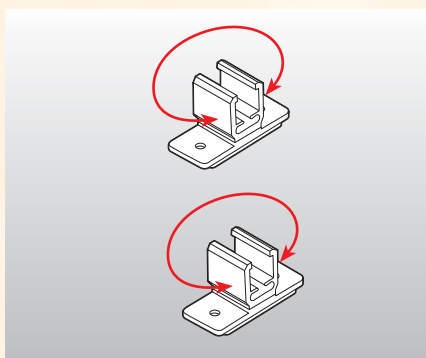

Peg-board connector with tube holder (148)



To attach frames to pegboards with hole centres at 30 mm (corresponds to European standard), plug components zinc-plated with tube holder grey, fits standard chromium tubes Ø 12 mm.

21720-03SU 10

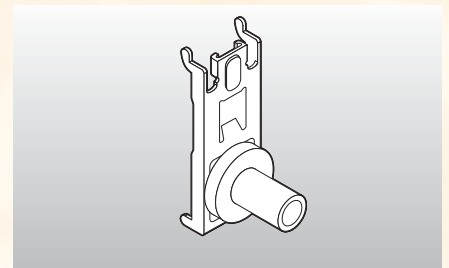

Cardboard clamp 10 (175)



To attach frames series 100 or 200 to cartons and boxes with up to 10 mm wall thickness, clear. T-piece to be ordered separately.

20511-00SU 10

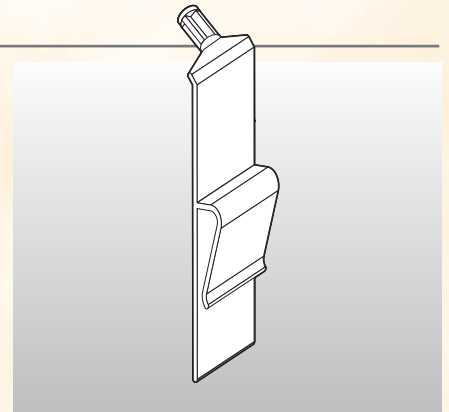

Cardboard clamp 20



To attach frames series 100 to cartons and boxes with up to 20 mm wall thickness, 2-part, clear.

21715-00SU 10

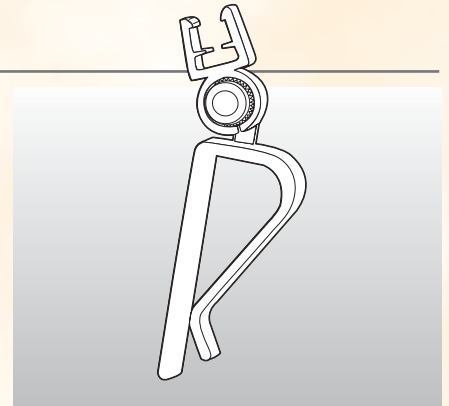

Cardboard clamp 140 with MF connector



To attach frames to boxes, fruit baskets or similar with up to 22 mm wall thickness, set consisting of clamp 140 black with hinge, MF-connector 50 mm black and t-piece in OEK standard colour.

35550-xxSU 1

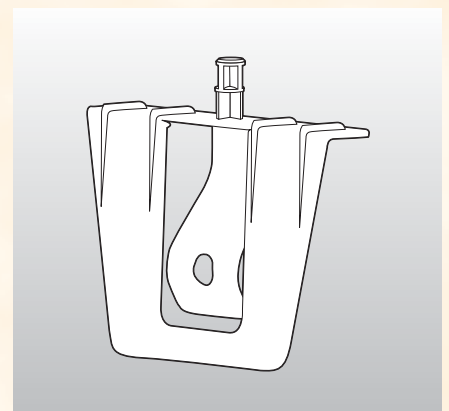



Clamp allrounder with rod

Revolving clamp, clamp range from 8 to 34 mm, clamp and rod made of plastics, colours: white, red, brown. Showcard frame and t-piece to be ordered separately.

20560-xx.....SU 1

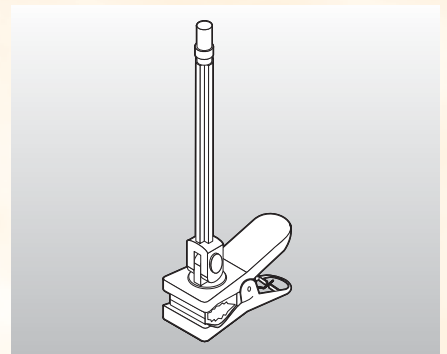

Square hanger (131)

To connect frames at a 90° angle, with hole for suspension cord, clear.

21040-00.....SU 10

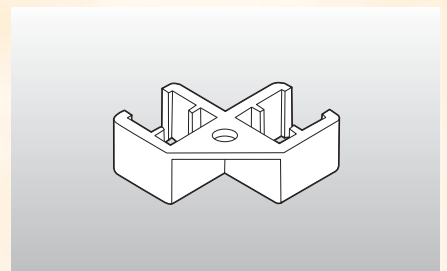

Triangular hanger (132)

To connect frames at a 60° angle, with hole for suspension cord, clear.

21050-00.....SU 10

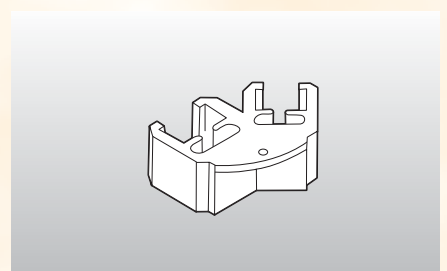

Hinged hanger (231/2)

For triangular and square connections, white.

22040-01.....SU 10

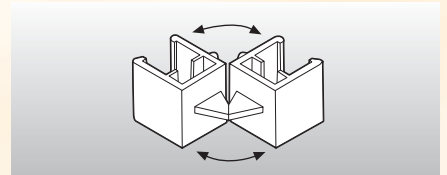

Adaptor parallel (133)

For combination of frames series 100 with Klick fasteners (see Klick accessories), clear.

21060-00.....SU 20

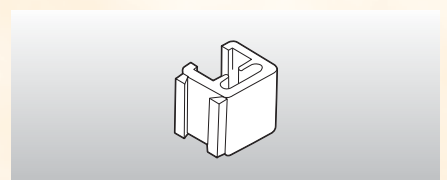



Adaptor 90° (134)

For combination of frames series 100 with Klick fasteners (see Klick accessories), clear.

21070-00.....SU 20

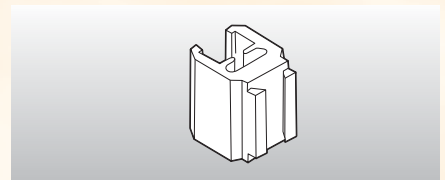

U-rail with adhesive

Extruded rail made of clear PVC, for frames series 100 to be fixed 90° to wall or ceiling, with double adhesive, clear. For outdoor use we recommend additional fixing by screws. Packing unit: 10 pcs.

length 1000 mm
21136-00/1000.....SU 10

length 2000 mm
21136-00/2000.....SU 10

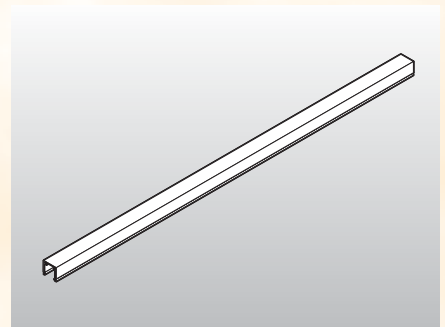

Frame holder for AHT-freezers (182)

Especially to mount frames series 100 to AHT-freezers, for optimum pricing and information, clear.

21770-00.....SU 10

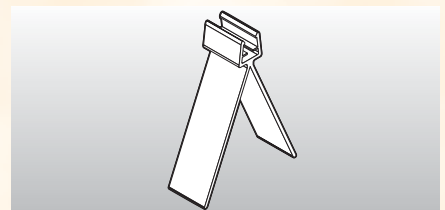

C-rail (160)

With double adhesive, profile 28 mm, length 2000 mm, white.

21660-00/2000.....SU 10

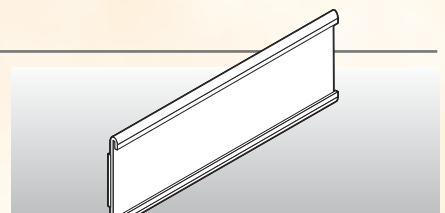

Fastener for C-rail 90° (161)

To clamp into C-rail, suits frames series 100, clear.

21663-00.....SU 10

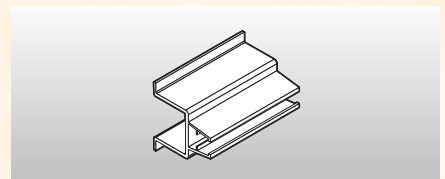

Fastener for C-rail parallel (162)

To clamp into C-rail, suits frames series 100, clear.

21665-00.....SU 10

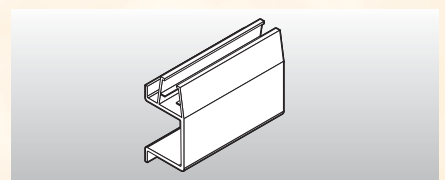

KS 1 oval tube clip

Showcard holder for textiles stand with oval tube 20 x 35 mm, clear. T-piece to be ordered separately.

20530-00SU 10

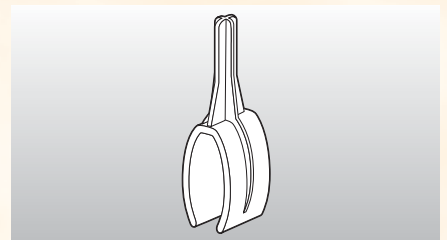

KS 1a flat oval tube clip

Showcard holder for textiles stand with flat oval tube 15 x 30 mm, clear. T-piece to be ordered separately.

20531-00SU 10

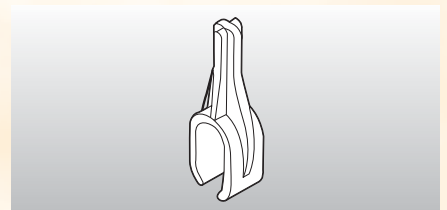

KS 3 oval tube clip

Showcard holder for textiles stand with oval tube 20 x 50 mm, clear. T-piece to be ordered separately.

20534-00SU 10

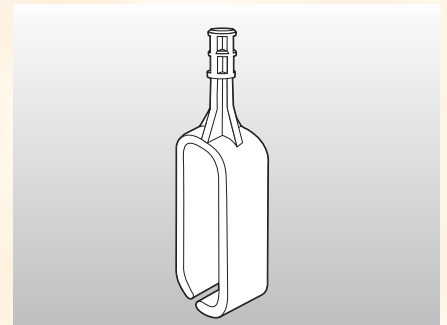

KS 4 oval tube clip

For markings of warehouse shelves, for tubes Ø 10 mm (to be ordered separately), white.

20535-01SU 10

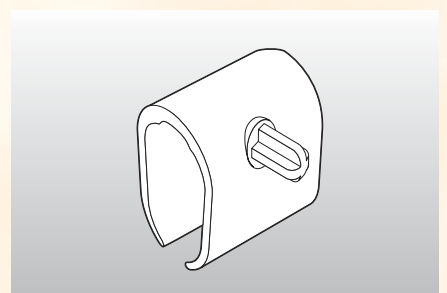

Round tube clip

Showcard holder for round tubes Ø 24 to 26 mm, for tubes Ø 10 mm (to be ordered separately), white.

20536-01SU 10

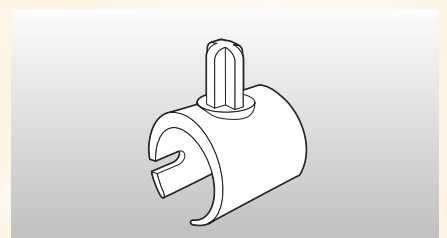

NEW!

NEW!



KS 2 O clamp for oval tube



Showcard holder for textiles stand with oval tube 20 x 35 mm, stable fixing, with chromium tube 160 mm, black. T-piece to be ordered separately.

20533-10/160SU 10

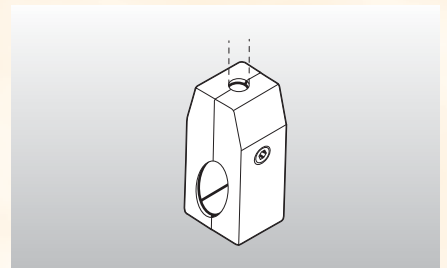

KS 2 R clamp for round tube

Showcard holder for textiles stand with round tube Ø 25 mm, stable fixing, with chromium tube 160 mm, black. T-piece to be ordered separately.

20532-10/160SU 10

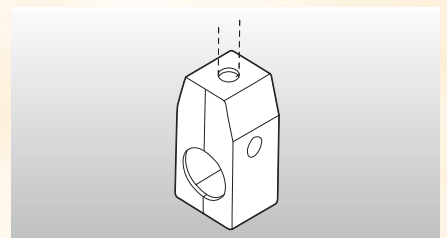

Jubilee clip



To fix frames to tubes with Ø > 25 mm, Jubilee clip zinc-plated with adjustable screw. T-piece to be ordered separately.

- Ø 25-40 mm
21740-00SU 10
- Ø 40-60 mm
21741-00SU 10
- Ø 60-80 mm
21742-00SU 10

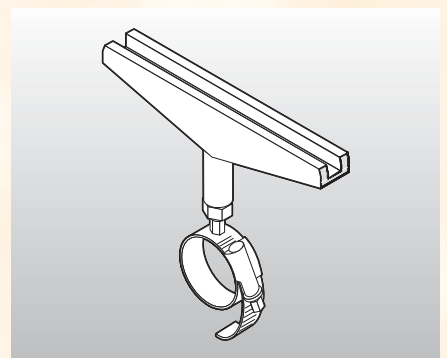

Showcard holder DK (pair)



Part A with locking screw, part B for bottom fixing of tube, suits wires up to Ø 8 mm, grey.

20545-03SU 10

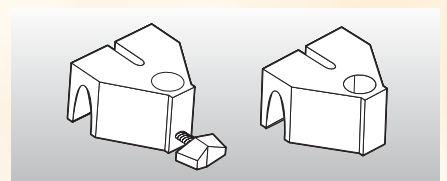

Fastener for plant container



For plant containers, type "A" for 1 frame, type "B" for 2 frames. T-piece to be ordered separately.

- Type "A"
20550-00SU 10
- Type "B"
20551-00SU 10

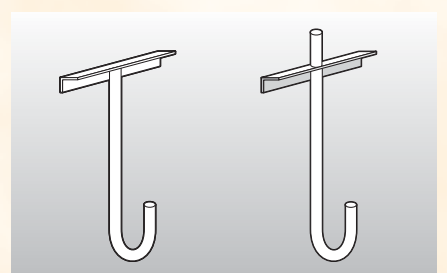



Notes